

Article number: 2072158M1615LAK
 Description: E+G indexing plunger
 GN 721.5-8-M16x1,5-LAK

Measures

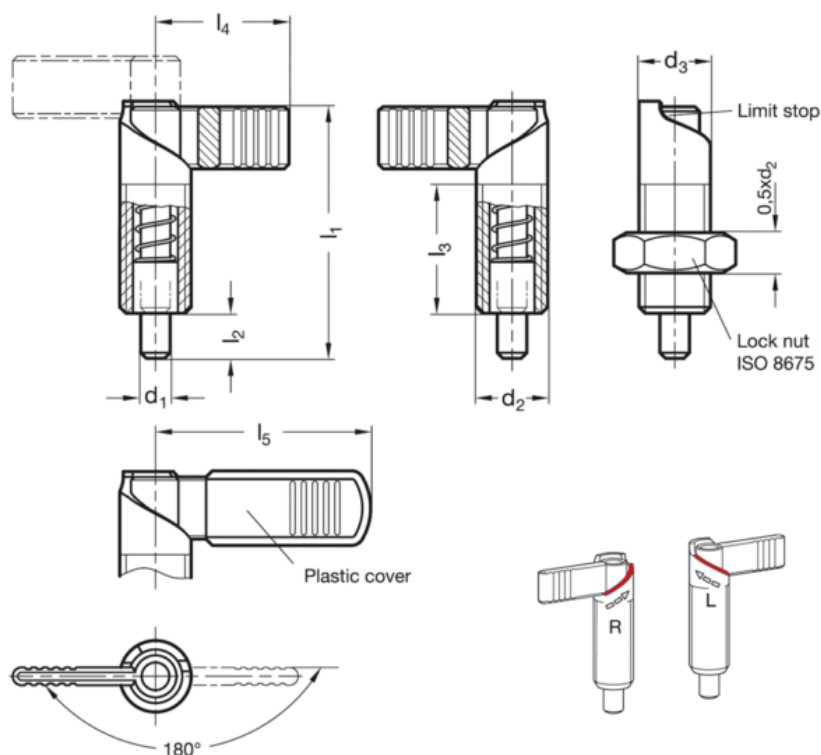

d1	= 8	l4	= 32
d2	= M16x1.5	l5	= -
d3	= 16	Weight in (g) = 150	
fjedbund	= 11		
fjedtop	= 29		
l1	= 56		
l2	= 10		
l3	= 30		